

CORR/GUARD[®]

SPECIAL GAS VENT

PRECISION ENGINEERED FOR FAST INSTALLATION

EXCLUSIVE SNAP-LOCK DESIGN

SINGLE WALL
DOUBLE WALL

3", 4" & 5" DIAMETER

METAL-FAB^{INC.}
An OLYMPIC STEEL Company

MODEL CGV - VALUE • MODEL CG - STANDARD

Corr/Guard® makes your job easier with exclusive benefits... the Gold Standard of Special Gas Vent!

FAST, EASY INSTALLATION

One-step connection and snap lock - just slide together until it "clicks" tight, no tools required.
Moderate insertion force needed.
Fewer supports required on horizontal runs.

QUICK AVAILABILITY

Ships in as little as 2-3 days.
100% order fill.

NO SAGGING

Tight overlap and lock prevent sag and "wobble".
Fewer supports needed.

LEAKPROOF BLACK SEAL

Seamless, precision formed "VITON" gasket.
Tight tolerance pipe.
Snap lock.

PRECISION ENGINEERED BLACK QUALITY

Gasket is molded to fit, not extruded/spliced.
Continuous weld inside the flue on elbows, not taped.
Laser welded pipe.
Consistently close tolerances.
Pressure rated to 10 inches of water column.
UNS S 44735 (i.e. AL29-4C) or 444 corrosion resistant stainless steel.
UL Listed - tested and labeled to UL1738 for Category II, III & IV appliances.
Limited Lifetime Warranty. (Standard Corr/Guard Value series not included.)

FULL LINE

3", 4" & 5" diameters, 6" - 48" lengths. (For 6" - 36" dia. refer to L2610 design manual.)
Complete selection of components.

MULTIPLE APPLICATIONS

Single Wall Special Vent Pipe
Double Wall Special Vent Pipe
Double Wall can also be used for Direct Vent applications if approved by appliance manufacturers. .

Specify the model that fits your application:

CG - Standard: UNS S44735 (i.e. AL29-4C) superferritic stainless steel, limited lifetime warranty.

See price list L1758.

Example:

Single Wall Straight Length = CGSW

CGV - Value: 444 stainless steel, five year warranty.

See price list L1758.

Example:

Single Wall Straight Length = CGVSW

One-step connection...fastest on the market!

*Just push together until the snap-lock tabs "click" into locked position,
your assurance of a leak-free connection.*

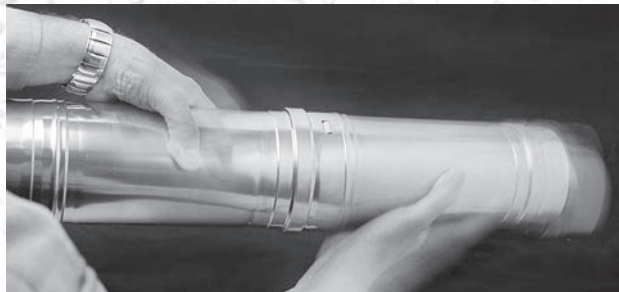

CORR/GUARD PRODUCT INFORMATION

APPLICATION INFORMATION	DOUBLE WALL	SINGLE WALL
Maximum Operating Temperature	550 Degrees F (288 C)	550 Degrees F (288 C)
Maximum Operating Pressure	15" w.g.	15" w.g.
Clearance to Combustibles HORIZONTAL-Enclosed	3" Diameters 330 F (177 C) = 0" (0 mm) 480 F (249 C) = (152 mm) 550 F (288 C) = Do Not Enclose 4" & 5" Diameters 300 F (149 C) = 3" (76 mm) 480 F (249 C) = 6" (152 mm) 550 F (288 C) = Do Not Enclose	3 & 4" Diameters 480 F (249 C) = 8" (203 mm) 550 F (288 C) = Do Not Enclose Do Not Enclose 5" Diameter
Clearance to Combustibles HORIZONTAL-Unenclosed	3" Diameters 330 F (177 C) = 0" (0 mm) 550 F (288 C) = 1" (25 mm) 4" & 5" Diameters 550 F (288 C) = 1" (25 mm)	3 & 4" Diameters 400 F (204 C) = 1" (25 mm) 550 F (288 C) = 2" (51 mm)
Clearance to Combustibles VERTICAL-Enclosed	3" Diameters 400 F (204 C) = 0" (0 mm) 480 F (249 C) = 1" (25 mm) 550 F (288 C) = Do Not Enclose 4" & 5" Diameters 480 F (249 C) = 1" (25 mm) 550 F (288 C) = Do Not Enclose	3 & 4" Diameters 480 F (249 C) = 4" (102 mm) 550 F (288 C) = Do Not Enclose 5" Diameter 480 F (249 C) = 6" (152 mm) 550 F (288 C) = Do Not Enclose
Clearance to Combustibles VERTICAL-Unenclosed	3" Diameters 400 F (204 C) = 0" (0 mm) 550 F (288 C) = 1" (25 mm) 4" & 5" Diameters 550 F (288 C) = 1" (25 mm)	3 & 4" Diameters 400 F (204 C) = 1" (25 mm) 550 F (288 C) = 2" (51 mm)
Joint Connection	Gasketed; No Sealant Required	Gasketed; No Sealant Required
Flue Material & Thickness	UNS S44735 (i.e. AL29-4C) (0.015 Thick) 444(0.015 Thick)	UNS S44735 (i.e. AL29-4C) (0.015 Thick) 444(0.015 Thick)
Casing Material & Thickness	Aluminized Steel (0.018 Thick)	Not Applicable
Optional	430 Stainless Steel (0.015 Thick)	Not Applicable
Optional	304 Stainless Steel (0.024 Thick)	Not Applicable
Optional	316 Stainless Steel (0.024 Thick)	Not Applicable

CODES AND STANDARDS



Corr/Guard is listed to UL 1738, Standard for Venting Systems for Gas-Burning Appliances, Categories II, III, and IV. These requirements cover venting systems intended for venting Category II, III, and IV gas-burning appliances as defined by the Standard for Gas-Fired Central Furnaces (except Direct Vent Central Furnaces), ANSI Z21.47 and the National Fuel Gas Code, NFPA 54. Venting systems covered by these requirements are intended to be used with Category II, III, and IV appliances that have been installed in accordance with NFPA 54, and with codes such as the BOCA National Mechanical Code, the Standard Mechanical Code, the Uniform Mechanical Code, and local codes.

Corr/Guard vent material is UNS S44735 (i.e. AL29-4C) superferritic stainless steel or 444 corrosion stainless steel. This vent is intended for use wherever appliance manufacturers specify superferritic stainless steel as the required vent material and, vent gas temperatures do not exceed those listed in the Metal-Fab Installation Instructions and the Application section of this manual.

New York City, NY MEA Approval No. 78-00-E

For complete details on Corr/Guard 6"-36" diameter vent, please see the Corr/Guard Design Manual, Form No. L2610

SINGLE WALL CORR/GUARD APPLICATION DRAWINGS

ROOF EXHAUST

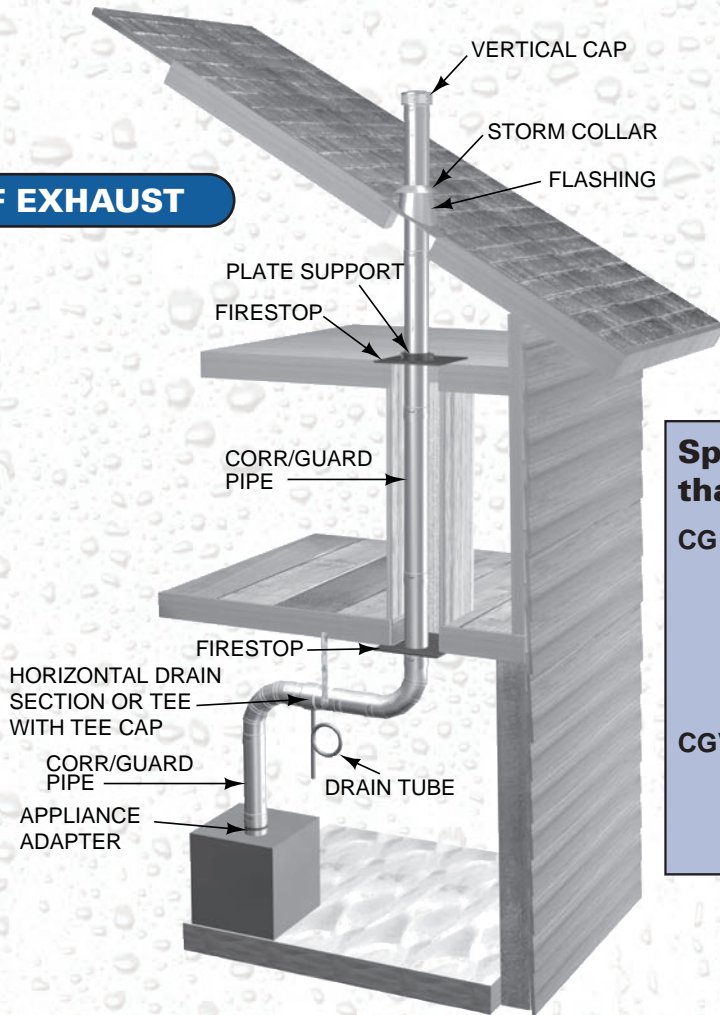

Specify the model that fits your application:

CG - Standard: UNS S44735 (i.e. AL29-4C) superferritic stainless steel, limited lifetime warranty.

See price list L1758.

Example:

Single Wall Straight Length = CGSW

CGV - Value: 444 stainless steel, five year warranty.

See price list L1758.

Example:

Single Wall Straight Length = CGVSW

SIDEWALL EXHAUST

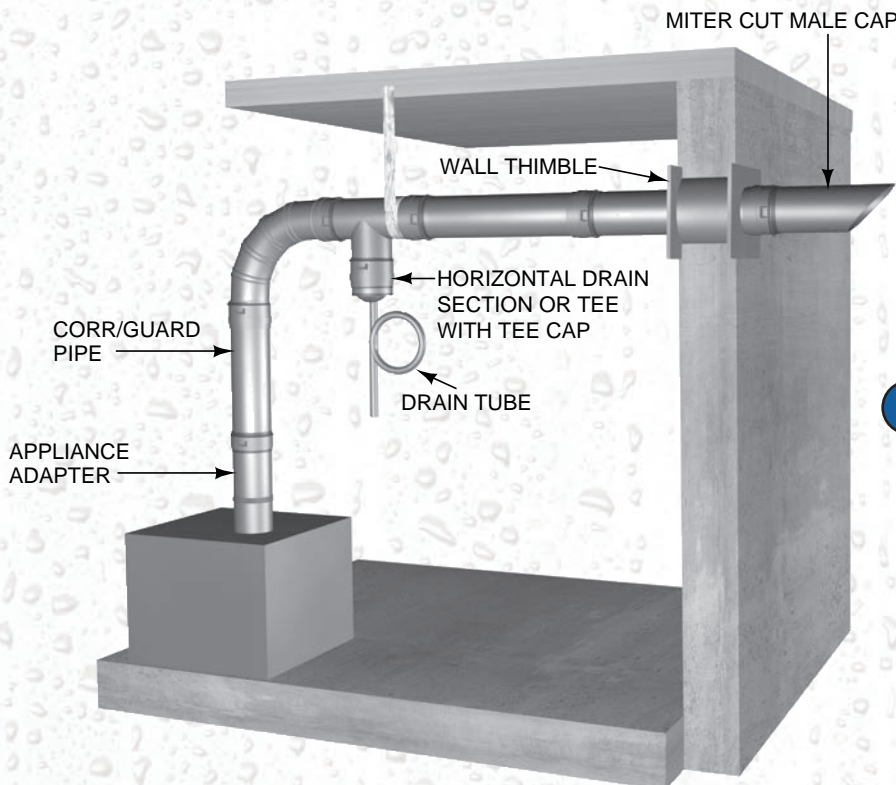

SINGLE WALL CORR/GUARD

NOTE: Corr/Guard pipe overlaps 2.25" when joined together, therefore assembled length is 2.25" less than listed length.

STRAIGHT LENGTH - CGSW

I.D.	L
3.00"	5.66"
3.00"	11.66"
3.00"	17.66"
3.00"	23.66"
3.00"	35.66"
3.00"	47.66"
4.00"	5.66"
4.00"	11.66"
4.00"	17.66"
4.00"	23.66"
4.00"	35.66"
4.00"	47.66"
5.00"	5.66"
5.00"	11.66"
5.00"	17.66"
5.00"	23.66"
5.00"	35.66"
5.00"	47.66"

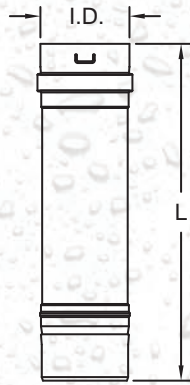

STRAIGHT LENGTH W/SCREEN

CGSWHTM (MALE)



I.D.
3.00"
4.00"
5.00"

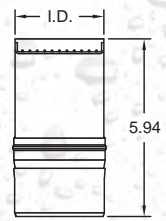

CGSWHTF (FEMALE)

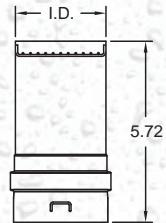

VARIABLE LENGTH

CGSWVL (VL10)

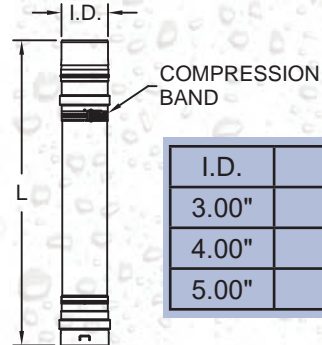

I.D.	L
3.00"	7.50" TO 10.00"
4.00"	7.50" TO 10.00"
5.00"	7.50" TO 10.00"

MALE TO MALE ADAPTER - CGSWDMA

I.D.
3.00"
4.00"
5.00"

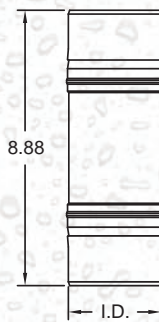

CGSWVL (VL22)



3.00"	7.50" TO 22.00"
4.00"	7.50" TO 22.00"
5.00"	7.50" TO 22.00"

FEMALE TO FEMALE ADAPTER - CGSWDFA

I.D.
3.00"
4.00"
5.00"

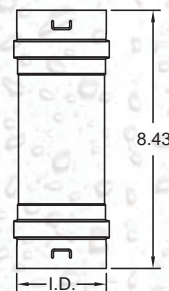

SINGLE WALL CORR/GUARD

NOTE: Be sure to specify the model that fits your specification, prefix CG or CGV.

90° ELBOW - CGSW90L; CGSW90SL

PART #	A	B	C	D
3CGSW90L	8.13"	8.00"	16.13"	13.94"
4CGSW90L	8.13"	8.00"	16.13"	13.94"
5CGSW90L	8.13"	8.00"	16.13"	13.94"
3CGSW90SL	5.56"	5.56"	11.13"	8.88"
4CGSW90SL	5.56"	5.56"	11.13"	8.88"

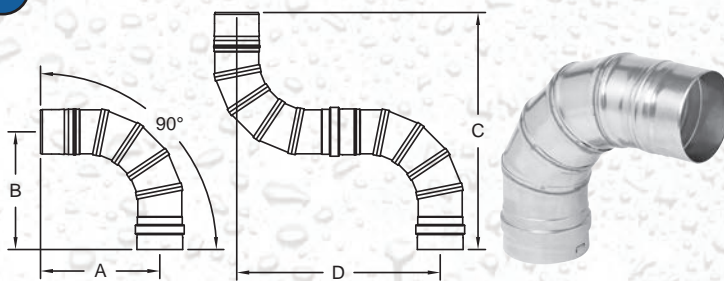

90° ELBOW W/SCREEN

CGSW90LTF (FEMALE)

CGSW90LTM (MALE)

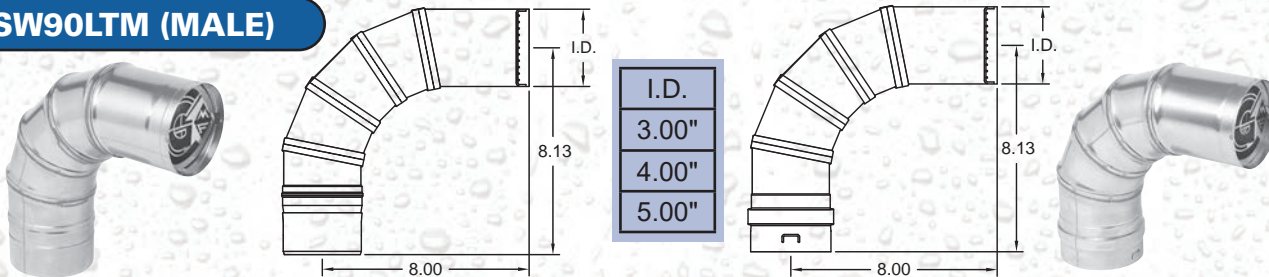

45° ELBOW - CGSW45L

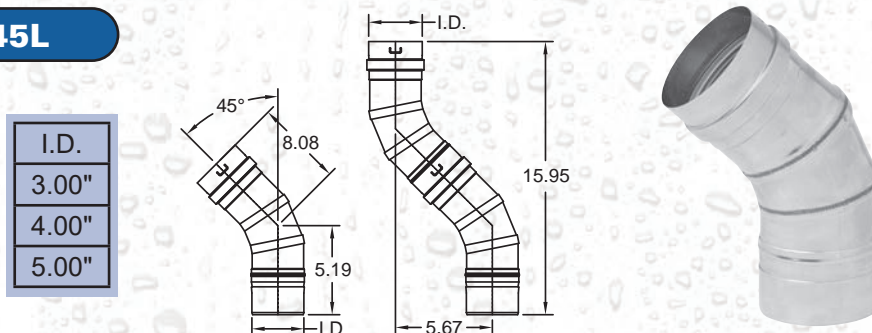

90° TEE - CGSWT

I.D.	A
3.00"	10.00"
4.00"	11.00"
5.00"	12.00"

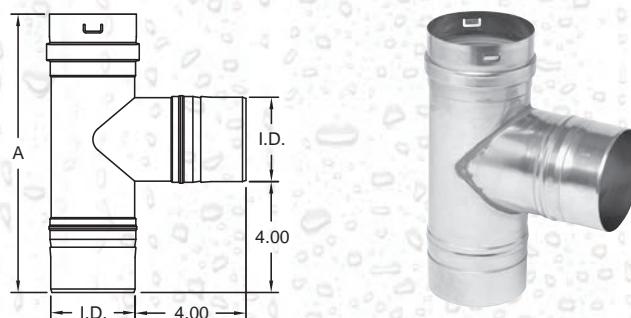

TEE W/SCREEN

CGSWTTF (FEMALE)

CGSWTTM (MALE)

I.D.	A
3.00"	9.00"
4.00"	10.00"
5.00"	11.00"

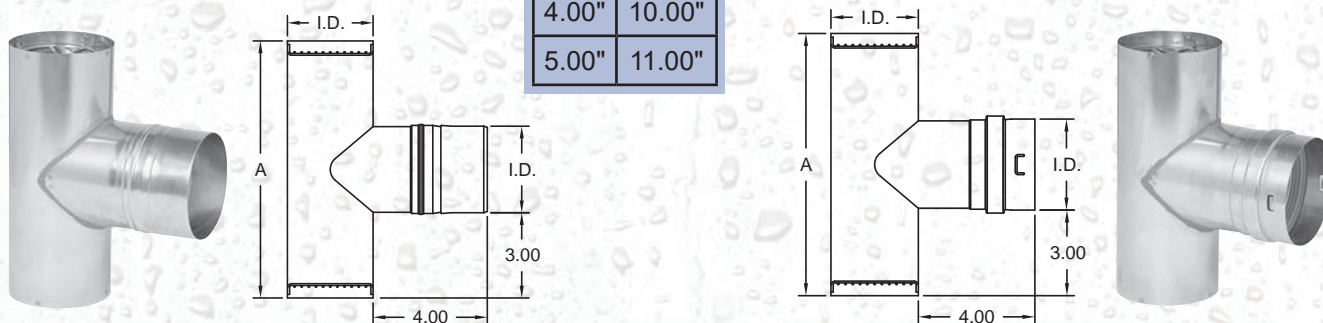

SINGLE WALL CORR/GUARD

NOTE: Corr/Guard pipe overlaps 2.25" when joined together, therefore assembled length is 2.25" less than listed length.

TEE CAP

W/O DRAIN FITTING - CGSWTCN

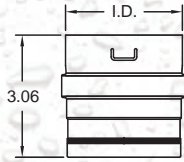

I.D.
3.00"
4.00"
5.00"

W/ DRAIN FITTING - CGSWTC

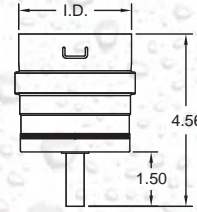

BOOT TEE - CGSWBT

I.D.	A
3.00"	11.50"
4.00"	12.50"
5.00"	13.50"

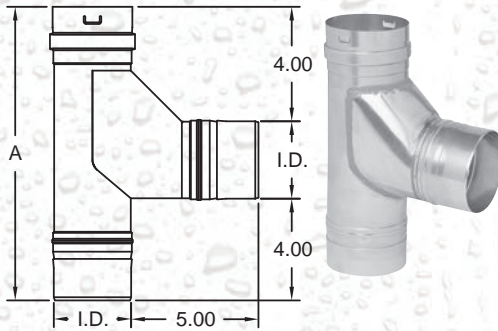

HORIZONTAL DRAIN SECTION - CGSWDS

I.D.
3.00"
4.00"
5.00"

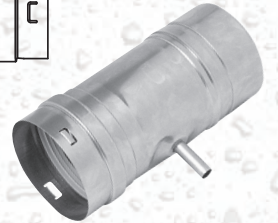
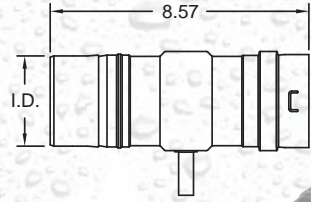

VERTICAL DRAIN SECTION - CGSWVDS

I.D.
3.00"
4.00"
5.00"

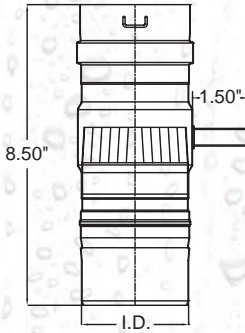

VERTICAL CAP - CGSWC

I.D.	A
3.00"	8.25"
4.00"	8.25"
5.00"	10.00"

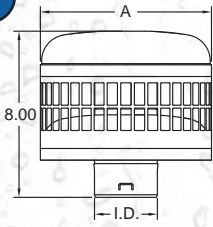

MITER CUT CAP

CGSWMCM - (MALE)

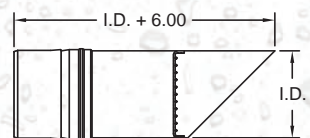

I.D.
3.00"
4.00"
5.00"

CGSWMCF - (FEMALE)

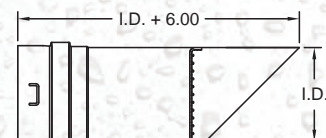

SINGLE WALL CORR/GUARD

NOTE: Corr/Guard pipe overlaps 2.25" when joined together, therefore assembled length is 2.25" less than listed length.

ECCENTRIC REDUCER - CGSWER

CGSWER

A	B
4.00"	3.00"
5.00"	4.00"

FCSER

A	B
6.00"	4.00"
6.00"	5.00"
8.00"	4.00"

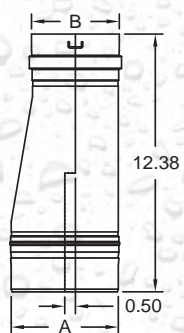

ECCENTRIC INCREASER

CGSWEI

A	B	C
3.00"	4.00"	0.50"
3.00"	5.00"	1.00"
4.00"	5.00"	0.50"



FCGSWEI

A	B	C
4.00"	6.00"	1.00"
5.00"	6.00"	0.50"
5.00"	8.00"	1.50"

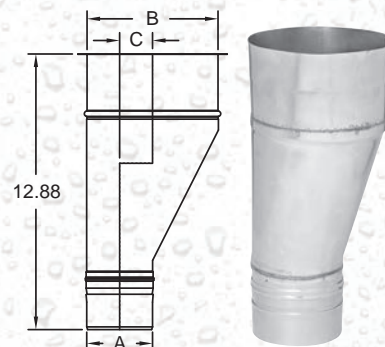

WALL THIMBLE - CGSWWPK

Adjusts from 4.5" to 7.5" wall thickness

A	B	C
3.16"	12.00"	3.50" TO 7.50"
4.16"	13.00"	3.50" TO 7.50"
5.16"	14.00"	3.50" TO 7.50"

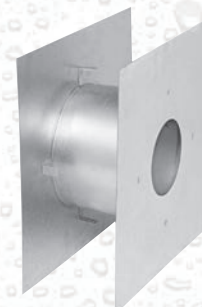
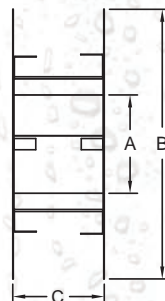

WALL HANGER - CGSWWH2

I.D.	A	B
3.00"	4.10"	3.50"
4.00"	5.10"	4.00"
5.00"	6.10"	4.50"

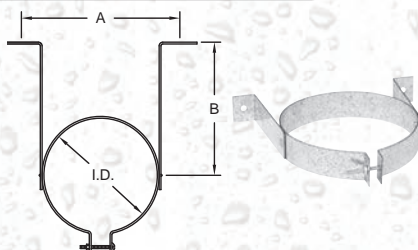

WALL SUPPORT - CGSWWS2

I.D.	A	B
3.00"	3.38"	4.12"
4.00"	3.88"	5.12"
5.00"	4.38"	6.12"

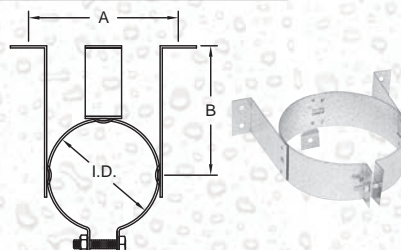
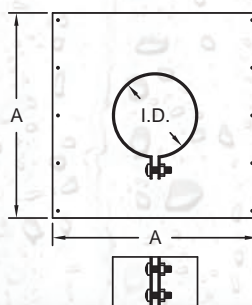

PLATE SUPPORT - CGSWPS

I.D.	A
3.00"	17.00"
4.00"	17.00"
5.00"	25.00"



SINGLE WALL CORR/GUARD

NOTE: Be sure to specify the model that fits your specification, prefix CG or CGV.

GUY RING - CGSWGR

I.D.
3.00"
4.00"
5.00"

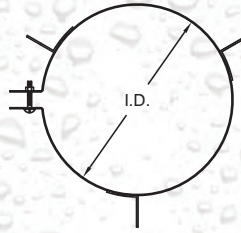

TALL CONE FLASHING - CGSWFT

A	B SQUARE
3.50"	14.63"
4.50"	14.63"
5.50"	19.63"

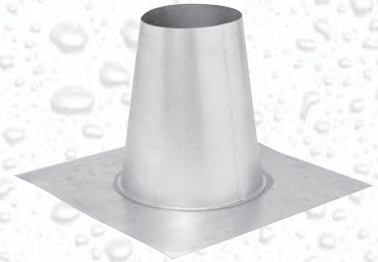
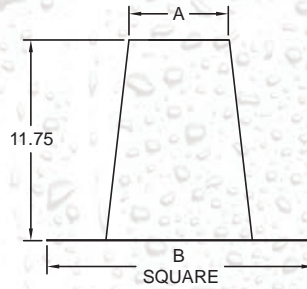

6/12 TO 12/12 PITCH FLASHING - CGSWF-12

A	PLATE DIMENSION (L x W)
3.50"	20.00" x 20.00"
4.50"	21.00" x 28.00"
5.50"	21.00" x 28.00"

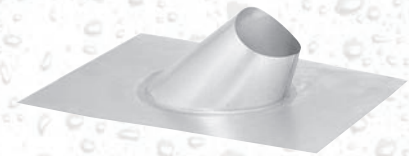
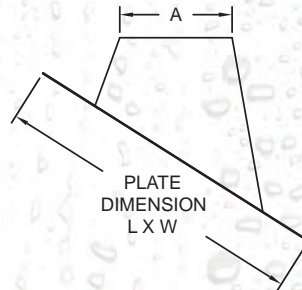

2/12 TO 5/12 PITCH FLASHING - CGSWF

A	B SQUARE
3.50"	14.63"
4.50"	14.63"
5.50"	19.63"

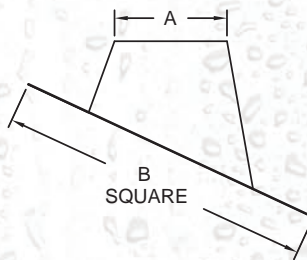

STORM COLLAR - CGSWSC

I.D.
3.00"
4.00"
5.00"

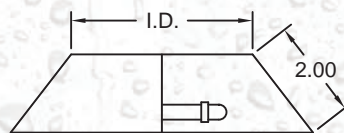

DOUBLE WALL CORR/GUARD APPLICATION DRAWINGS

ROOF EXHAUST

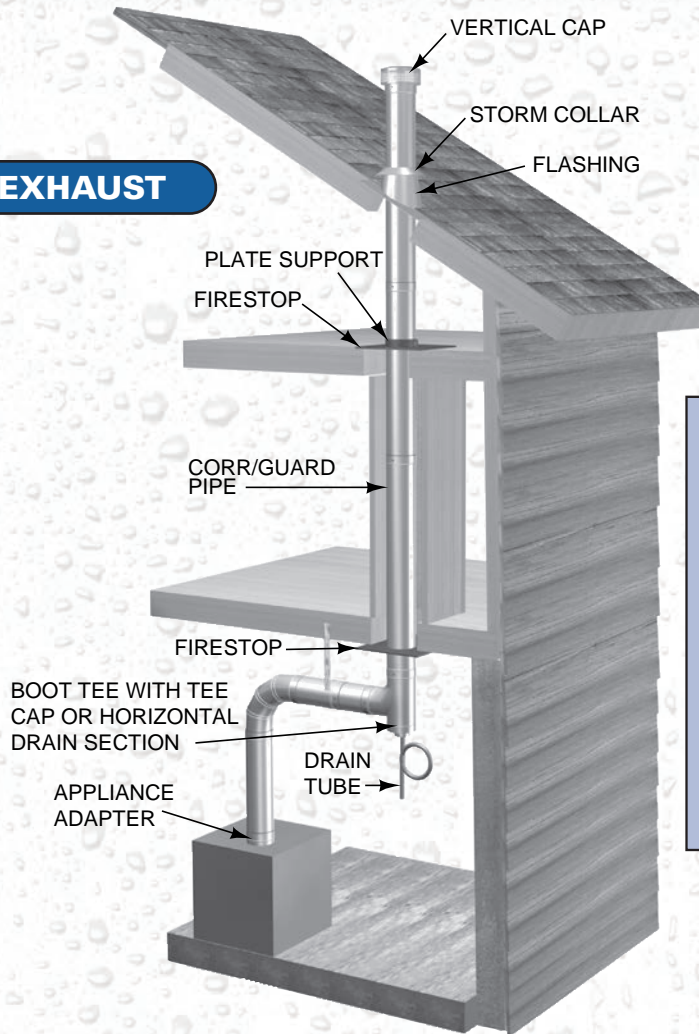

Specify the model that fits your application:

CG - Standard: UNS S44735 (i.e. AL29-4C) stainless steel, limited lifetime warranty. See price list L1758.

Example:
Single Wall Straight Length = CGSW

CGV - Value: Superferritic stainless steel, five year warranty. See price list L1758.

Example:
Single Wall Straight Length = CGVSW

NOTE: Casing end closure (Model CEC) can be used to transition single wall to double wall.

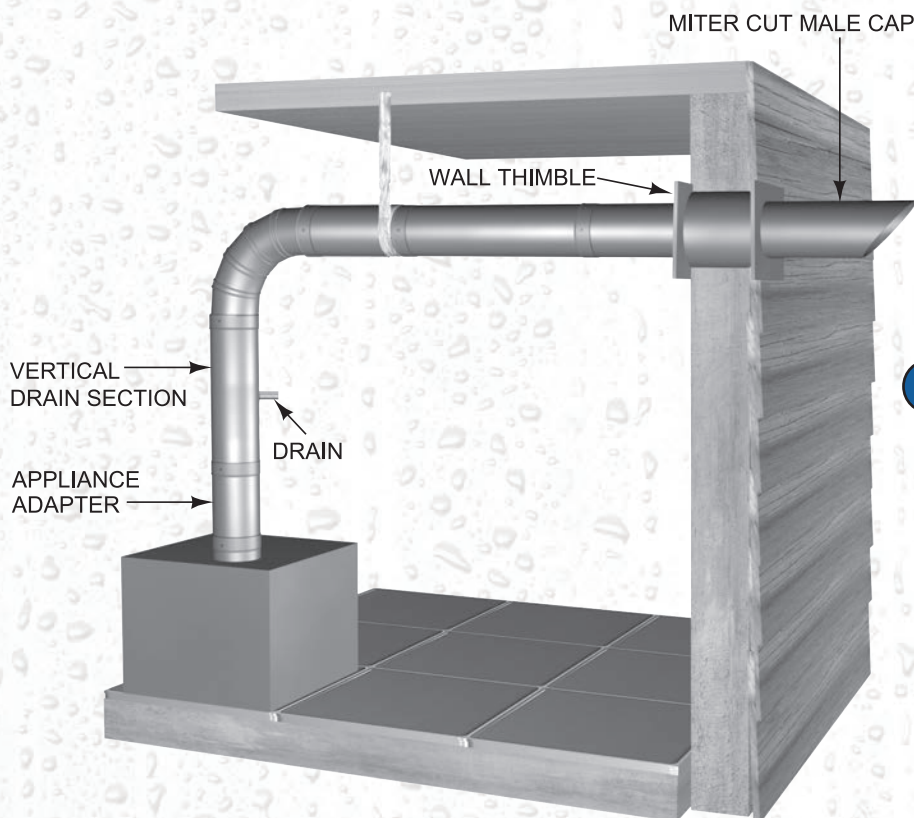

SIDEWALL EXHAUST

DOUBLE WALL CORR/GUARD

NOTE: Corr/Guard pipe overlaps 2.25" when joined together, therefore assembled length is 2.25" less than listed length.

STRAIGHT LENGTH - CG

I.D.	A	L
3.00"	5.00"	5.66"
3.00"	5.00"	11.66"
3.00"	5.00"	17.66"
3.00"	5.00"	23.66"
3.00"	5.00"	35.66"
3.00"	5.00"	47.66"
4.00"	6.00"	5.66"
4.00"	6.00"	11.66"
4.00"	6.00"	17.66"
4.00"	6.00"	23.66"
4.00"	6.00"	35.66"
4.00"	6.00"	47.66"
5.00"	7.00"	5.66"
5.00"	7.00"	11.66"
5.00"	7.00"	17.66"
5.00"	7.00"	23.66"
5.00"	7.00"	35.66"
5.00"	7.00"	47.66"

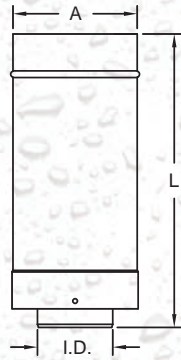

STRAIGHT LENGTH W/SCREEN

CGHTM (MALE)

I.D.
3.00"
4.00"
5.00"

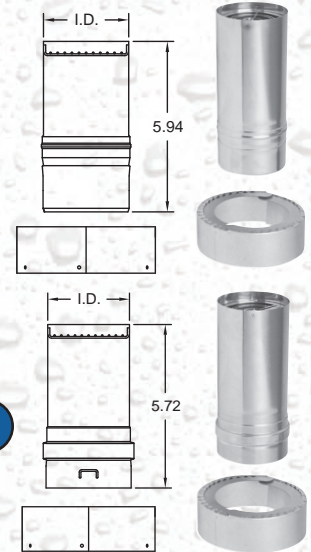

CGHTF (FEMALE)

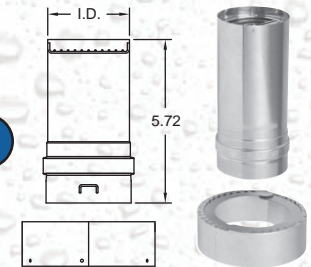

VARIABLE LENGTH

CGVL (VL10)

CGVL (VL22)

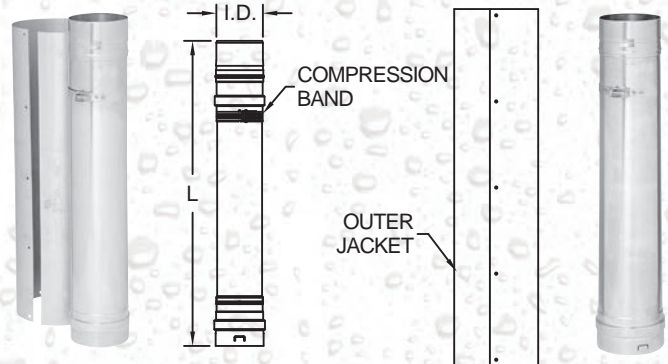

VL10

I.D.	L
3.00"	7.50" TO 10.00"
4.00"	7.50" TO 10.00"
5.00"	7.50" TO 10.00"

VL22

I.D.	L
3.00"	7.50" TO 22.00"
4.00"	7.50" TO 22.00"
5.00"	7.50" TO 22.00"

MALE TO MALE ADAPTER - CGDMA

I.D.	A
3.00"	5.00"
4.00"	6.00"
5.00"	7.00"

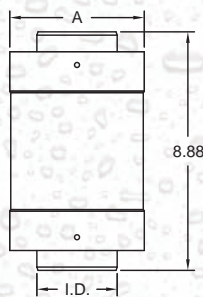

FEMALE TO FEMALE ADAPTER - CGDFA

I.D.	A
3.00"	5.00"
4.00"	6.00"
5.00"	7.00"

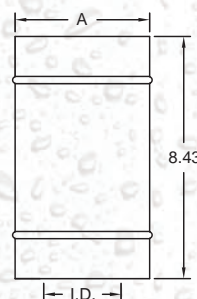

DOUBLE WALL CORR/GUARD

NOTE: Corr/Guard pipe overlaps 2.25" when joined together, therefore assembled length is 2.25" less than listed length.

90° ELBOW - CG90L

I.D.
3.00"
4.00"
5.00"

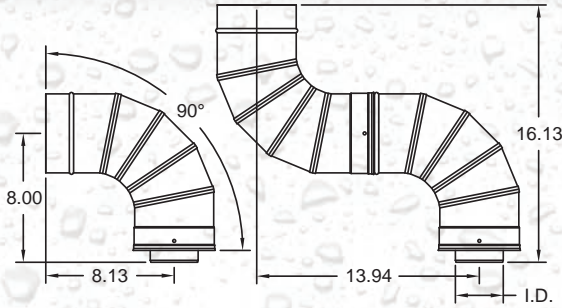

90° ELBOW W/SCREEN

CG90LTM (MALE)

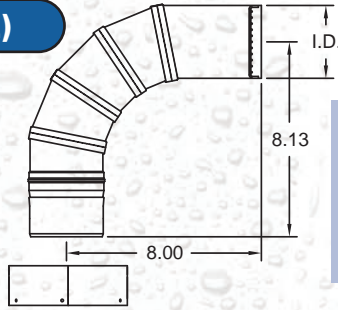

I.D.
3.00"
4.00"
5.00"

CG90LTF (FEMALE)

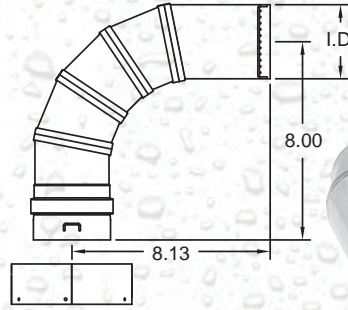
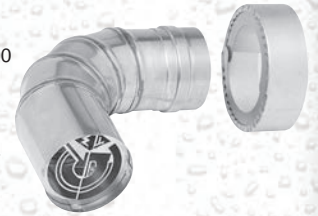

45° ELBOW - CG45L

I.D.
3.00"
4.00"
5.00"

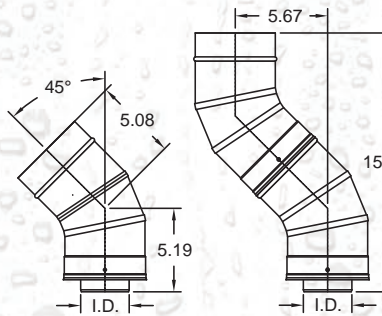

90° TEE - CGT

I.D.	O.D.	A	B
3.00"	5.00"	10.00"	9.25"
4.00"	6.00"	11.00"	10.25"
5.00"	7.00"	12.00"	11.25"

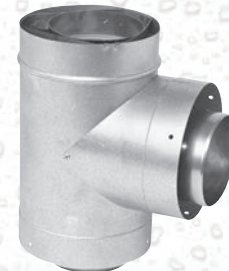
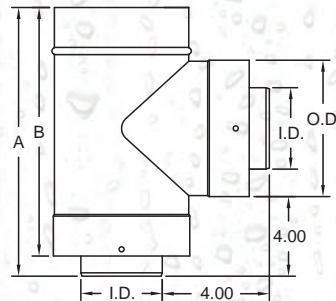

TEE W/SCREEN

CGTTM (MALE)

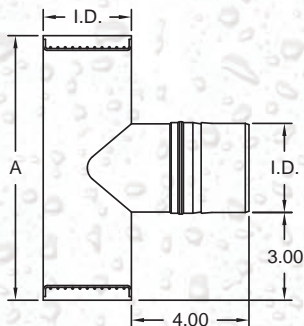

I.D.	A
3.00"	9.00"
4.00"	10.00"
5.00"	11.00"

CGTTF (FEMALE)

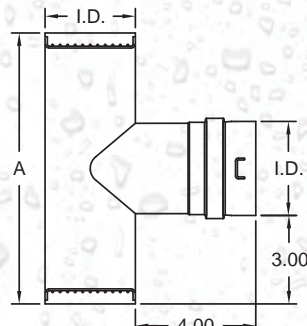

DOUBLE WALL CORR/GUARD

NOTE: Be sure to specify the model that fits your specification, prefix CG or CGV.

TEE CAP

W/O DRAIN FITTING - CGTCN

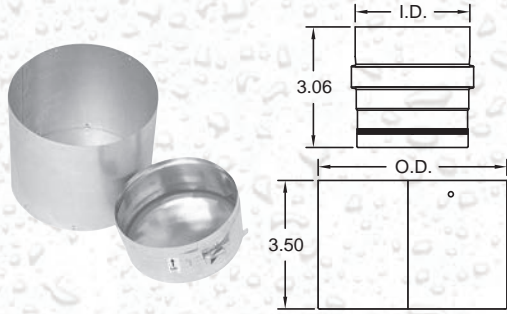

I.D.	A
3.00"	5.00"
4.00"	6.00"
5.00"	7.00"

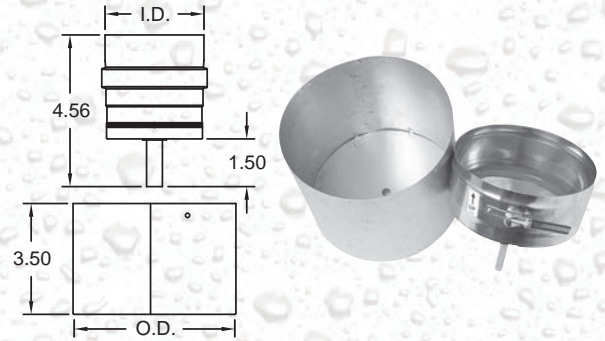

BOOTTEE - CGBT

I.D.	O.D.	A
3.00"	5.00"	11.50"
4.00"	6.00"	12.50"
5.00"	7.00"	13.50"

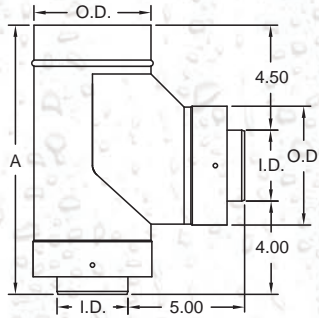

HORIZONTAL DRAIN SECTION - CGDS

I.D.
3.00"
4.00"
5.00"

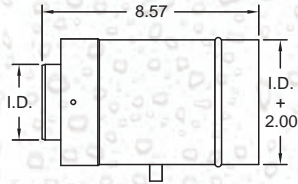

VERTICAL CAP - CGC

I.D.	A
3.00"	8.25"
4.00"	8.25"
5.00"	10.00"

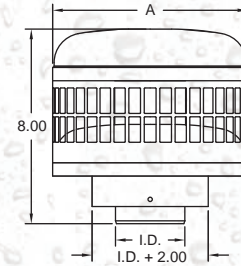

VERTICAL DRAIN SECTION - CGVDS

I.D.	A
3.00"	5.00"
4.00"	6.00"

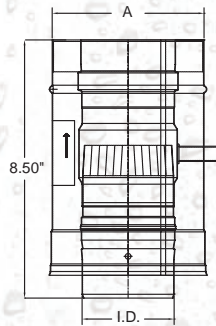

MITER CAP

MALE CAP - CGMCM

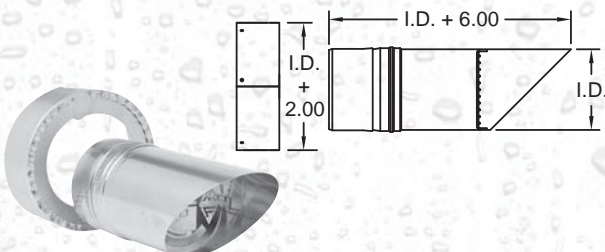

I.D.
3.00"
4.00"
5.00"

FEMALE CAP - CGMCF

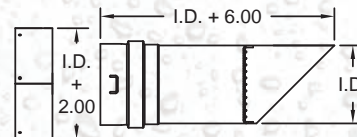

DOUBLE WALL CORR/GUARD

NOTE: Be sure to specify the model that fits your specification, prefix CG or CGV.

ECCENTRIC INCREASER

TO 4" & 5" DIA. - CGEI

A	B	C
3.00"	4.00"	0.50"
3.00"	5.00"	1.00"
4.00"	5.00"	0.50"

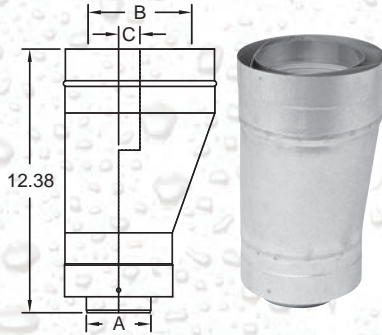

TO 6" DIA. - FCSEI6

A	B
3.00"	1.50"
3.00"	1.00"
4.00"	0.50"

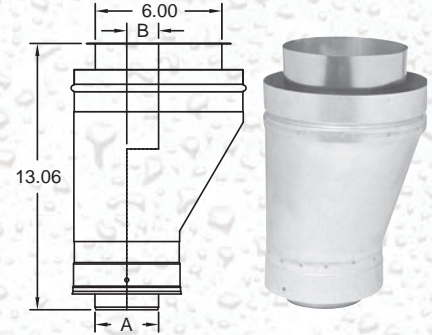

ECCENTRIC REDUCER - CGER

A	B
4.00"	3.00"
5.00"	4.00"

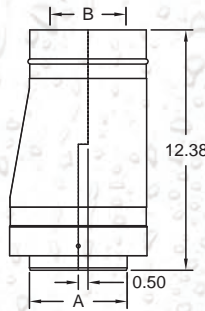

WALL THIMBLE - CGWPK

Adjusts from 4.5" to 7.5" wall thickness

A	B	C
5.16"	12.00"	4.50" TO 7.50"
6.16"	13.00"	4.50" TO 7.50"
7.16"	14.00"	4.50" TO 7.50"

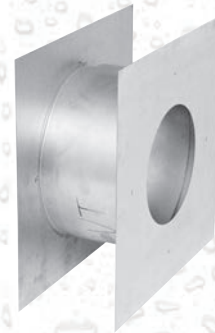
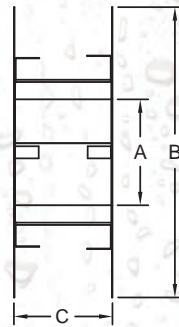
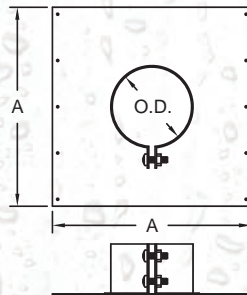

PLATE SUPPORT - CGPS

I.D.	A
5.00"	17.00"
6.00"	17.00"
7.00"	17.00"



WALL SUPPORT - CGWS

O.D.	A	B
5.00"	6.12"	3.38"
6.00"	7.12"	3.88"
7.00"	8.12"	4.38"

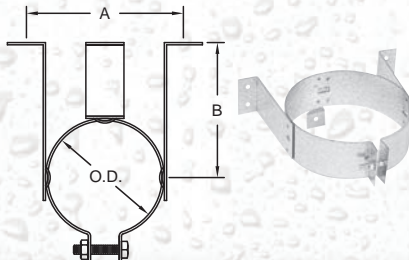

WALL HANGER - CGWH

O.D.	A	B
5.00"	6.10"	3.50"
6.00"	7.10"	4.00"
7.00"	8.10"	4.50"

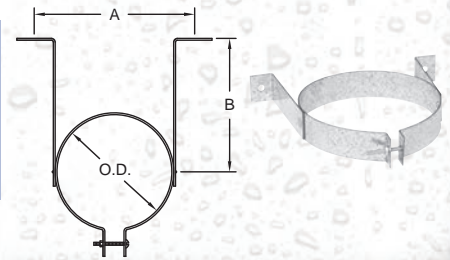

DOUBLE WALL CORR/GUARD

NOTE: Corr/Guard pipe overlaps 2.25" when joined together, therefore assembled length is 2.25" less than listed length.

GUY RING - CGGR

PART #	O.D.
3CGGR	5.00"
4CGGR	6.00"
5CGGR	7.00"

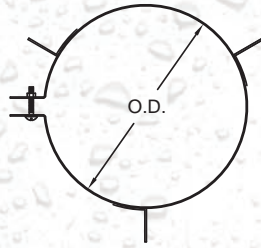

TALL CONE FLASHING - CGFT

PART #	A	B SQUARE
3CGFT	5.50"	14.63"
4CGFT	6.50"	17.50"
5CGFT	7.50"	19.00"

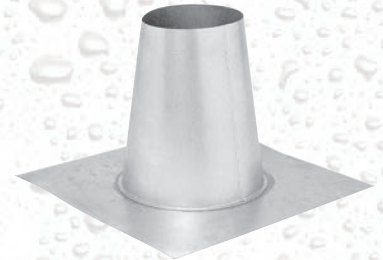
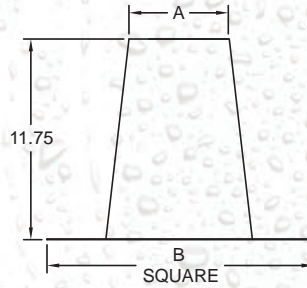

6/12 TO 12/12 PITCH FLASHING - CGF-12

A	PLATE DIMENSION (L x W)
3.50"	20.00" x 20.00"
4.50"	21.00" x 28.00"
5.50"	21.00" x 28.00"

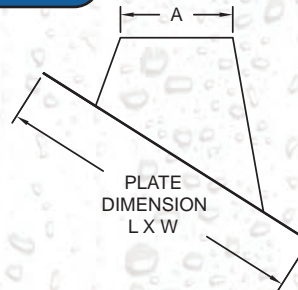

2/12 TO 5/12 PITCH FLASHING - CGF

A	B SQUARE
5.50"	14.63"
6.50"	17.50"
7.50"	19.00"

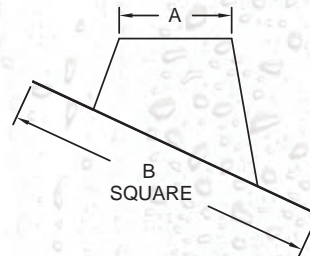

STORM COLLAR - CGSC

I.D.
5.00"
6.00"
7.00"

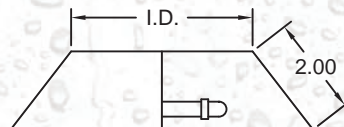

CORR/GUARD KITS

NOTE: Be sure to specify the model that fits your specification, prefix CG or CGV.

HORIZONTAL VENT KIT - 3CGSWHVK 3" AND 4"

NOTE: 4" Kit includes appliance adapter

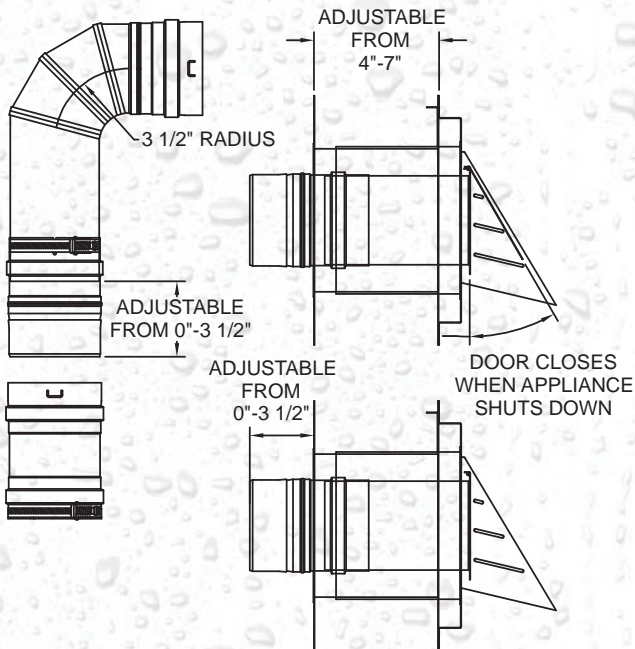

VERTICAL VENT KIT - 4CGSWVVK

Vertical Cap



Storm Collar

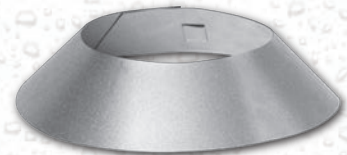

Flashing 2/12 through 5/12 pitch

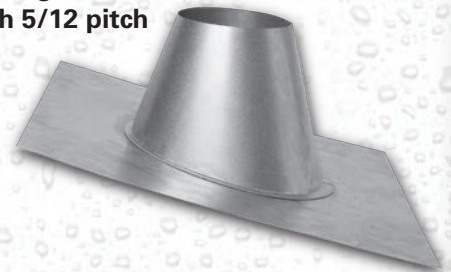

Vertical Drain Section



Double Gasket Appliance Adapter



4/7 COAXIAL HORIZONTAL TERMINATION - 4CG7HTL LEFT AND RIGHT ASSEMBLIES - 4CG7HTR

LEFT ASSEMBLY

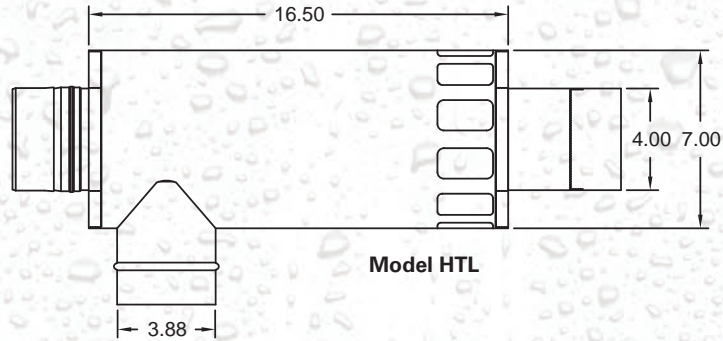

RIGHT ASSEMBLY

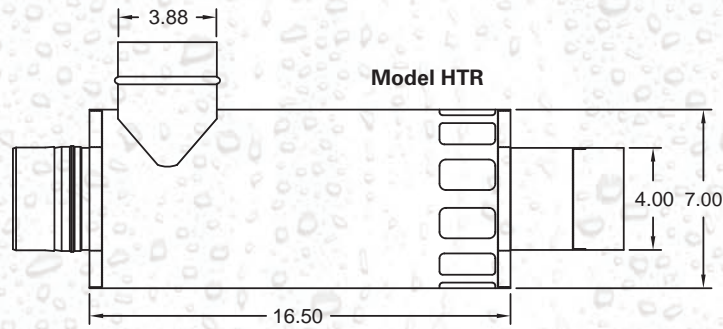

HORIZONTAL TERMINATION ASSEMBLY - 4CG7HT90L LEFT AND RIGHT ASSEMBLIES - 4CG7HT90R

LEFT ASSEMBLY

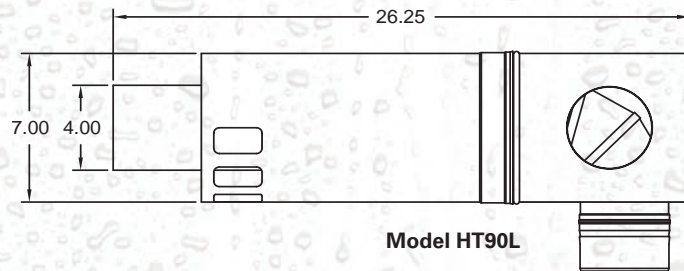

RIGHT ASSEMBLY

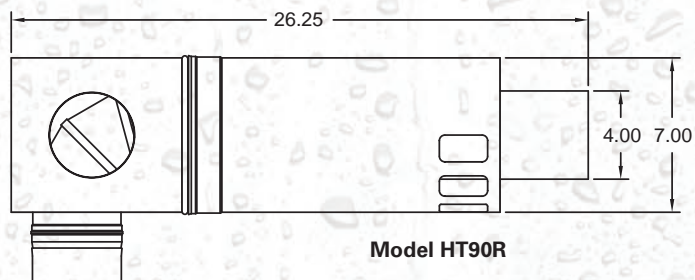

HORIZONTAL APPLIANCE ADAPTERS

- 3CGRLSH RINNAI HORIZONTAL APPLIANCE ADAPTER

I.D.	O.D.
3.00"	5.00"

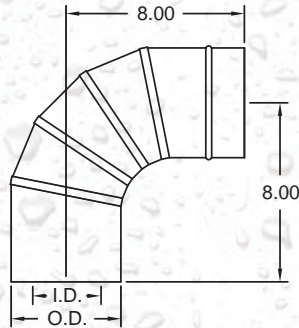

HORIZONTAL TERMINATIONS

- 3CGRHT RINNAI HORIZONTAL TERMINATION
- 3CGVPHT RHEEMI HORIZONTAL TERMINATION
- 3CGVPHT3 RHEEM HORIZONTAL TERMINATION
- 3CGVPHT4 RHEEM HORIZONTAL TERMINATION
- 3CGVTR TRIM RING

I.D.
3.00"

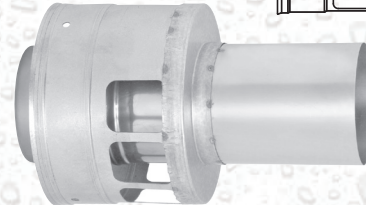
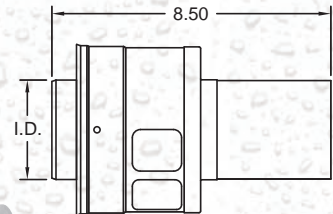

VERTICAL APPLIANCE ADAPTERS

- 3CGRLSV RINNAI APPLIANCE ADAPTER
- 3CGPA RHEEM APPLIANCE ADAPTER
- 3CGVPA RHEEM APPLIANCE ADAPTER

A	I.D.
5.06"	3.00"

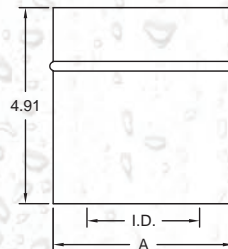

VERTICAL TERMINATIONS

- 3CGRVT RINNAI VERTICAL TERMINATION
- 3CGVPVT RHEEM VERTICAL TERMINATION

I.D.
3.00"

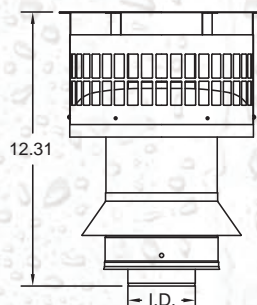

**How does your Special Gas Vent stack up to Metal-Fab?
Use this handy chart to evaluate your current supplier.**

	Metal-Fab	Heat Fab	ProTech	Z-Flex
1. One-Step Snap Lock	X			
2. Fewest Supports Required	X			
3. No Sag and Wobble	X			
4. Seamless Precision Gasket	X			
5. Continuously Welded Elbows	X			
6. Laser Welded Pipe	X			
7. Consistently Close Tolerances	X			
8. Pressure Rated to 10" W.C.	X			
9. UNS S44735 (i.e. AL29-4C)	X			
10. Limited Lifetime Warranty	X			
11. Friendly Customer Service	X			
12. Shipping in 2-3 Days	X			
13. Regional Warehouses	X			
14. 100% Order Fill	X			
15. E-Mail Order Acknowledgement	X			
16. E-Mail Order Tracking	X			
17. Stretched Wrapped Skids	X			
18. Skid Stickers	X			
19. Skid Lists	X			
20. Convenient Unloading At Your Site	X			
21. Technical Support	X			

A FULL LINE OF QUALITY PRODUCTS

TYPE-B GAS VENT



Easiest installation on the market..Featuring SureLock B-Vent Locking System.

AIR-COOLED TEMP/GUARD®

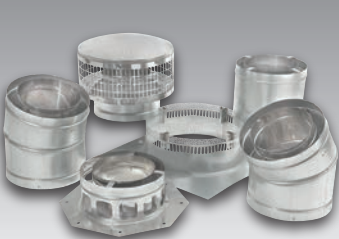

Complete line of Type-B Gas Vent products and accessories.

FLEXIBLE CHIMNEY LINERS



Comprehensive kits and accessories for all relining application.

TEMP/GUARD®



All-Fuel Chimney for use with listed wood, coal, oil and gas-fired appliances.

BIOMASS CHIMNEY



Tested and listed to UL 641, available in 3" and 4" diameters with a positive twist lock connection.

BLACK STOVEPIPE



Single & Double wall components tested to UL 103.

FIRE & CEILING DAMPERS

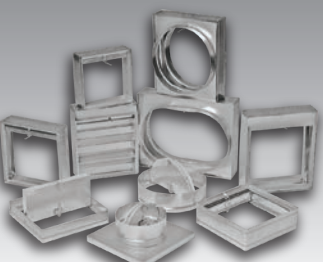

Complete line of fire and ceiling radiation dampers, 100% order fill with no backorders.

GRILLES & REGISTERS

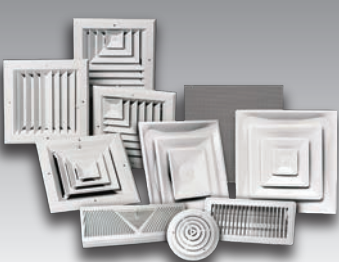

Grilles, Registers and Diffusers manufactured from heavy gauge steel and hand inspected to ensure quality.

DIRECT VENT



Sure-Seal Direct Vent, for use with approved gas-fired appliances.

METAL-FAB INC.
An OLYMPIC STEEL Company

P.O. BOX 1138 • WICHITA, KANSAS 67201 • (316) 943-2351 • FAX (316) 943-2717

E-mail: info@metal-fabinc.com • www.metal-fabinc.com

— 800-835-2830 —